

# HEX AREA 4821

PROJECT PROJCT
SPEC TYPE
NOTES



## FINISH FINI



BLKE-CHF

WHE-SGF

LGE-SGF

## FELT FINISH FINI FEUTRE



ADDITIONAL PREMIUM COLORS AVAILABLE – SEE ACOUSTIC MATERIAL COLOR OPTIONS PAGE

## FAMILY FAMILLE

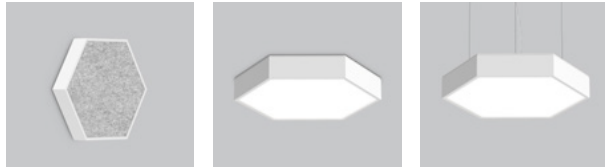

4721 (WALL SURFACE)

4720 (CEILING SURFACE)

4820



4715 (WALL SURFACE)

4715 (CEILING SURFACE)

4816

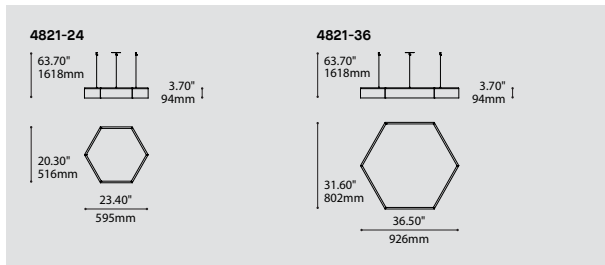

## ORDERING SPECIFICATION SPÉCIFICATION DE COMMANDE

CODE

### MODEL MODÈLE

- 4821-24 HEX AREA 24" – ACOUSTIC (NO LIGHT SOURCE)
- 4821-24 HEX AREA 24" – ACOUSTIC WITH INDIRECT LIGHT SOURCE
- 4821-36 HEX AREA 36" – ACOUSTIC (NO LIGHT SOURCE)
- 4821-36 HEX AREA 36" – ACOUSTIC WITH INDIRECT LIGHT SOURCE

### LIGHT SOURCE SOURCE LUMINEUSE

- LED REGULAR OUTPUT INDIRECT
- LED.HO HIGH OUTPUT INDIRECT

### COLOR TEMPERATURE TEMPÉRATURE DE COULEUR

- 27 2700K
  - 30 3000K
  - 35 3500K
  - 40\* 4000K
- \* LONGER LEAD TIME MAY APPLY, PLEASE CONTACT YOUR EUREKA REPRESENTATIVE AVAILABLE FOR 4821 ONLY

### COLOR RENDERING INDEX (CRI) INDICE DE RENDU DE COULEUR (IRC)

- 90 90+ CRI
- AVAILABLE FOR 4821 ONLY

### VOLTAGE VOLTAGE

- 120V 120 VOLT
  - 277V 277 VOLT
- AVAILABLE FOR 4821 ONLY

### CONTROL OPTION OPTION DE CONTRÔLE

- DV 0-10V DIMMING (120V-277V)
  - DP PHASE DIMMING (120V ONLY)
  - NLTAIR2\* NLIGHT AIR CONTROL GEN 2
  - NLIGHT\* NLIGHT WIRED CONTROL
- \* NLIGHT INTEGRATION REQUIRES A REMOTE POWER PACK (39NLAA FOR NLTAIR2 OR 39NLWA FOR NLIGHT).  
\* NLIGHT WITH EMERGENCY BATTERY PLEASE CONTACT YOUR EUREKA REPRESENTATIVE.  
REFER TO NLIGHT GUIDE AND INSTALLATION SHEET FOR ALL REQUIREMENTS.

### CABLE CABLE

- AC AIRCRAFT MOUNTING & CLEAR CABLE, FIELD ADJUSTABLE

### CABLE LENGTH LONGUEUR DE CABLE

- 60 60" AIRCRAFT CABLE (STD LENGTH)
  - \*\* CUSTOM AIRCRAFT CABLE LENGTH (PLEASE SPECIFY)
- FOR OVERALL LENGTH, PLEASE CONTACT YOUR EUREKA REPRESENTATIVE.

### MOUNTING MONTAGE

- RCA\* ROUND CANOPY / PAVILLON ROND
  - RC CENTERED ROUND CANOPY – AIRCRAFT CABLES ANGLED TO CENTER
- SCREWLESS 0.5" CANOPY (2471C)  
\*IF NO OPTION IS SELECTED, A ROUND CANOPY WITH STRAIGHT AIRCRAFT CABLES WILL BE PROVIDED.  
\*ONLY AVAILABLE FOR 4821!

### CANOPY FINISH FINI PAVILLON (A)

- BLKE BLACK FINE TEXTURE
  - WHE WHITE FINE TEXTURE
  - RAL\* PLEASE SPECIFY RAL CODE
- \* LONGER LEAD TIME MAY APPLY, PLEASE CONTACT YOUR EUREKA REPRESENTATIVE.  
(A) ONLY REQUIRED FOR 4821

### HOUSING FINISH FINI BOITIER

- BLKE BLACK FINE TEXTURE
  - WHE WHITE FINE TEXTURE
  - LGE LIGHT GREY FINE TEXTURE
  - RAL\* PLEASE SPECIFY RAL CODE
- \* LONGER LEAD TIME MAY APPLY, PLEASE CONTACT YOUR EUREKA REPRESENTATIVE

### FELT FINISH FINI FEUTRE

- ABF AZURE BLUE FELT
  - AWF ARCTIC WHITE FELT
  - BBF BASIC BLACK FELT
  - BOF BLOOD ORANGE FELT
  - BTF BATTLESHIP GRAY FELT
  - PREMIUM\* PLEASE SPECIFY PREMIUM COLOR CODE – SEE ACOUSTIC MATERIAL COLOR OPTIONS PAGE
  - BYF BANANA YELLOW FELT
  - CHF CHARCOAL FELT
  - NBF NAVY BLUE FELT
  - OBF OCEAN BLUE FELT
  - PGF PEAR GREEN FELT
  - REF RED FELT
  - SGF SILVER GRAY FELT
  - TGF TITANIUM GRAY FELT
  - ZFF ZINFANDEL FELT
- \* LONGER LEAD TIME MAY APPLY, PLEASE CONTACT YOUR EUREKA REPRESENTATIVE

### ACCESSORY ACCESSOIRE

- ALL ACCESSORIES ARE AVAILABLE FOR ADVANCE SHIPPING
  - 4903 CONNECTOR BRACKET FOR CLUSTER (ONE PER CONNECTED EDGE) (PLEASE SPECIFY QTY)
  - 39NLAA\* NLIGHT AIR GEN 2 REMOTE POWER PACK
  - 39NLWA\* NLIGHT WIRED REMOTE POWER PACK
- \*FOR CHICAGO PLENUM INSTALLATION, PLEASE CONTACT YOUR EUREKA REPRESENTATIVE.

## PRODUCT CHARACTERISTICS CARACTÉRISTIQUES DU PRODUIT



SPECIFICATION

# Acoustic Material Color Options for Hex Area



## Standard colors



**ABF**  
Azure Blue



**AWF**  
Arctic White

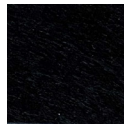

**BBF**  
Basic Black



**BOF**  
Blood Orange

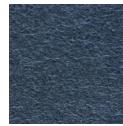

**BTF**  
Battleship Gray



**BYF**  
Banana Yellow



**CHF**  
Charcoal

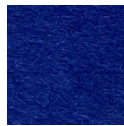

**NBF**  
Navy Blue

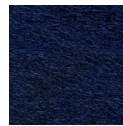

**OBF**  
Ocean Blue

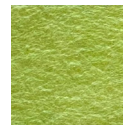

**PGF**  
Pear Green



**REF**  
Red



**SGF**  
Silver Gray

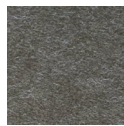

**TGF**  
Titanium Gray

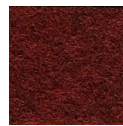

**ZFF**  
Zinfandel

## Premium colors



**BGF**  
Bubble Gum



**BKF**  
Bark Brown

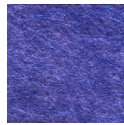

**DBF**  
Denim Blue

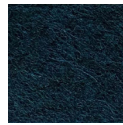

**DTF**  
Deep Teal Green



**DYF**  
Daisy Yellow

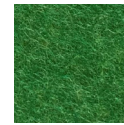

**GGF**  
Grass Green



**LBF**  
Light Beige



**LGF**  
Lime Green

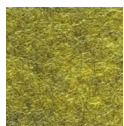

**MGF**  
Moss Green

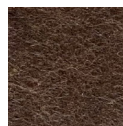

**OAF**  
Oak Brown



**PBF**  
Peanut Brown



**PNF**  
Pinot Noir

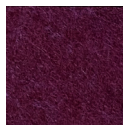

**PPF**  
Plum Purple



**SBF**  
Sky Blue



**TOF**  
Tangerine Orange



**TPF**  
Tulip Purple

- Premium colors carry extended lead times. Additional fees may apply for expedited lead times. Please consult factory.
- Due to the dye process, colors may vary slightly from batch to batch.

# HEX AREA ACOUSTIC 4821

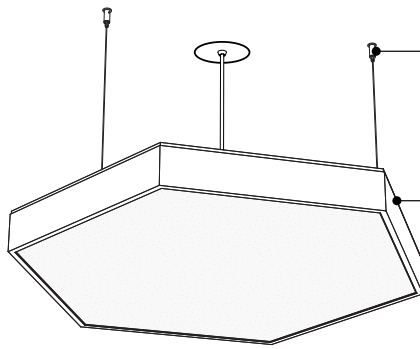

**SIMPLIFIED INSTALLATION**  
Position 3 steel aircraft cables anywhere around a junction box. Easy levelling with adjustable cable grippers

**SIMPLE AND CLEAN HOUSING**  
Precision welded aluminium extrusion. Clean geometry on the outside, structural details on the inside

4821-36

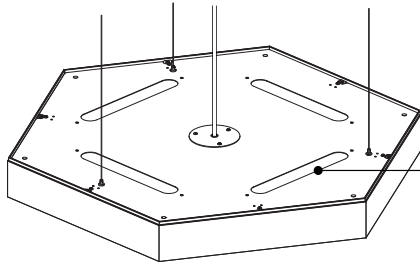

**COLORS**  
Available in 14 standard colors and 16 Premium colors. For all color options, refer to the Acoustic Material Color Options page.

**INDIRECT LIGHTING**  
Dedicated LED indirect lighting modules (48211)  
Minimum suspension height of 18" (48211)  
Powder-coated steel covers (4821)

**CLEANING**  
A proper and regular cleaning will help extend the lifespan of acoustic products. Remove dust with a vacuum cleaner and light stains with a damp cloth. For greasy and deep stains, a professional dry clean is recommended. Do not use any abrasive, soap, or chemical cleaner.

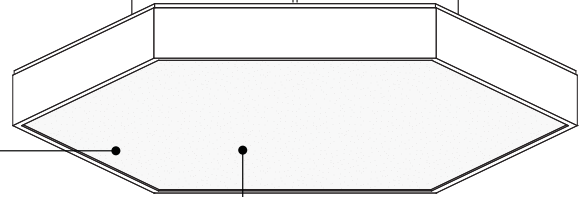

**FELT**  
High density polyester felt panels made from recycled bottles (PET)  
The panels are recyclable



**NOISE REDUCTION**  
The center of the product is a large sound absorbing panel that increase acoustic comfort.



Also available in lighting version. See product 4820.

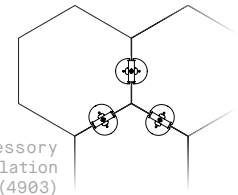

Connector bracket accessory available for cluster installation (4903)

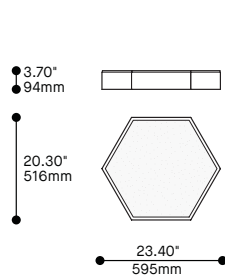

4821-24 / 48211-24

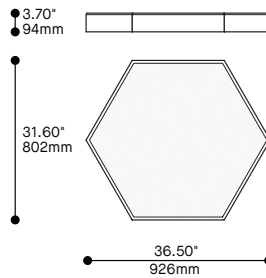

4821-36 / 48211-36

## PRODUCT SPECIFICATION

	4821-24	4821-36	48211-24	48211-36
<b>PERFORMANCE</b>			<b>REG / HO</b>	<b>REG / HO</b>
SYSTEM WATTAGE	-	-	20.0W / 40.0W	26.7W / 53.3W
DELIVERED INDIRECT LUMENS (4000K)	-	-	2050LM / 4100LM	2692LM / 5394LM
EFFICACY	-	-	102LM/W	100LM/W

## OTHER INFORMATIONS

LUMINAIRE'S WEIGHT	11.6LBS / 5.3KG	22.7LBS / 10.3KG	12.5LBS / 5.7KG	23.6LBS / 10.7KG
L70 (LUMEN MAINTENANCE)	N/A	N/A	> 60 000 HRS	> 60 000 HRS
FELT	HIGH DENSITY 9MM POLYESTER FELT			
ACOUSTIC	ACOUSTIC MATERIAL RATED AT 0.75 NRC			
FIRE RATING	ASTM E84-13 (FELT MATERIAL ONLY)			
LIGHT QUALITY			R9 > 50 (90 CRI OPTION)	R9 > 50 (90 CRI OPTION)

## EFFICACY MULTIPLIERS

CRI	CCT	FACTOR
90+	4000K	1.00
90+	3500K	0.96
90+	3000K	0.92
90+	2700K	0.87

## LIGHT DISTRIBUTION

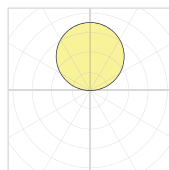

4821-XX



Visit our website for warranty terms and conditions.



## TECHNICAL DATA

# HEX AREA ACOUSTIQUE 4821

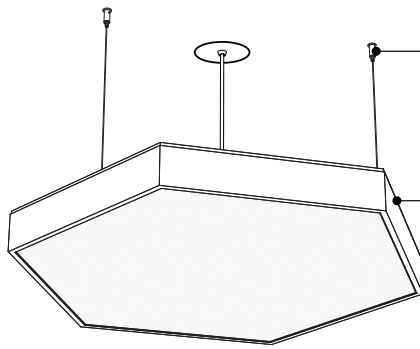

**INSTALLATION SIMPLIFIÉE**  
Situer les 3 câbles de suspension n'importe où autour de la boîte de connection. Mise à niveau et équilibrage rapide avec serre câbles ajustables

**BOÎTIER SOBRE**  
Extrusion d'aluminium soudée avec précision. Lignes nettes et modernes à l'extérieur, détails structuraux cachés à l'intérieur

4821-36

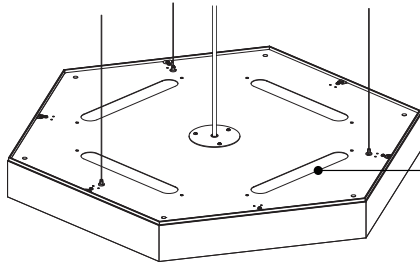

**COULEURS**  
Disponible en 14 couleurs standards et 16 couleurs Premium. Pour la charte de couleurs consultez la fiche d'options de couleurs

**ÉCLAIRAGE INDIRECT**  
Module LED d'éclairage indirect (48211)  
Suspension minimum de 18" (48211)  
Plaquettes en acier peintes (4821)

**NETTOYAGE**

Un nettoyage approprié et régulier contribuera à prolonger la durée de vie des produits acoustiques. Enlever la poussière avec un aspirateur et les taches légères avec un linge humide. Pour les tâches importantes ou grasses, un nettoyage à sec est recommandé. Ne pas utiliser de produits abrasifs, de savon ou de produits nettoyants chimiques.

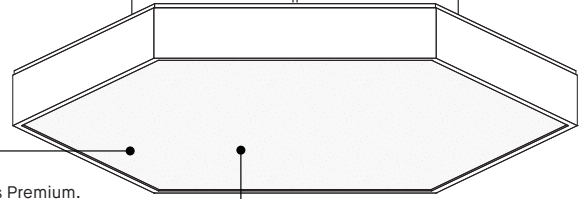

**FEUTRE**

Panneaux de polyester haute densité faits de bouteilles de plastique recyclées (PET)  
Les panneaux sont recyclables



**ATTÉNUATION DU BRUIT**

Le centre de produit est un grand panneau acoustique qui absorbe le son.



Aussi disponible en version luminaire. Voir le produit 4820.

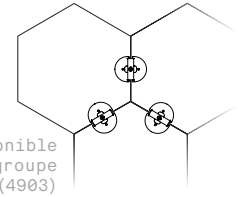

Plaque de support disponible pour l'installation de groupe (4903)

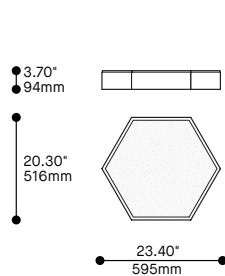

4821-24 / 4821-24

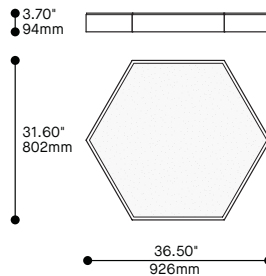

4821-36 / 4821-36

**SPÉCIFICATION PRODUIT**

**4821-24**

**4821-36**

**4821-24**

**4821-36**

**PERFORMANCE**

	4821-24	4821-36	4821-24	4821-36
PUISSANCE TOTALE	-	-	20.0W / 40.0W	26.7W / 53.3W
LUMENS RÉELS INDIRECT (4000K)	-	-	2050LM / 4100LM	2692LM / 5394LM
EFFICACITÉ			102LM/W	100LM/W

**AUTRES INFORMATIONS**

X

POIDS DU LUMINAIRE	11.6LBS / 5.3KG	22.7LBS / 10.3KG	12.5LBS / 5.7KG	23.6LBS / 10.7KG
L70 (MAINTENANCE DE LA LUMIÈRE) FEUTRE	N/A	N/A	> 60 000 H	> 60 000 H
FEUTRE ACOUSTIC	FEUTRE DE POLYESTER HAUTE DENSITÉ 9MM MATÉRIEL ACOUSTIQUE GRADÉ À 0.75 NRC			
RÉSISTANCE AU FEU	ASTM E84-13 (MATÉRIEL FEUTRE SEULEMENT)			
QUALITÉ DE LA LUMIÈRE			R9 > 50 (OPTION 90 IRC)	R9 > 50 (OPTION 90 IRC)

**FACTEURS D'EFFICACITÉ**

CRI	CCT	FACTEUR
90+	4000K	1.00
90+	3500K	0.96
90+	3000K	0.92
90+	2700K	0.87

**DISTRIBUTION LUMINEUSE**

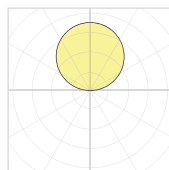

4821-XX



VisiteznotresiteWebpourlestermesetconditions.



**DONNÉES TECHNIQUES**